

YAMAHA KX-500A *RS*

Natural Sound Stereo Cassette Deck

CENTER

TABLE OF CONTENTS

Points Which Differ from the KX-500/U	1
Front Panel	2
Rear Panel and Connections	3
Detector Slots	4
Recording Protection	4
Tape Slack	4
Timer Connection	4
Owner's Manual of KX-500/U	6

OWNER'S MANUAL

KX-500A, *Natural Sound Stereo Cassette Deck*

Thank you for purchasing the YAMAHA KX-500A stereo cassette deck.

The KX-500A is identical to the KX-500/U except that a microphone amplifier has been added. Therefore, the deck's operation, etc. is the same as that of KX-500/U with the exception of the "Points Which Differ from the KX-500/U" listed below.

The page numbers below refer to the KX-500/U Owner's Manual, which starts from page 6.

Points Which Differ from the KX-500/U

1. Model Number : Changed from KX-500/U to KX-500A.
2. Remote Control Unit : The KX-500A does not include a remote control transmitter or batteries, but it is equipped with a remote control sensor. Wireless operation is therefore possible with the purchase of a separate remote control transmitter.
3. Microphone Amplifier :
 - A single set of terminals on the rear panel is used as both the microphone jacks and the LINE IN terminals.
 - A slide switch next to the terminals on the rear panel allows the user to select either "LINE" or "MIC". Before selecting either "LINE" or "MIC", be sure to set the MASTER FADER to the " $-\infty$ dB" position.
 - The procedure for setting the recording level when using microphone input is the same as that for the KX-500/U. (See pages 16 and 17.)
4. Specifications :

Add the following microphone amplifier specifications to the specifications given on page 24.

Input Impedance (MIC).....3.5 k ohms
Input Level (MIC)1 mV
5. Dimensions (W x H x D).....435 x 117 x 274.5mm
(17-1/8" x 4-5/8" x 10-3/16")
6. Weight4.6kg (10 lbs. 2 oz.)

1 FRONT PANEL

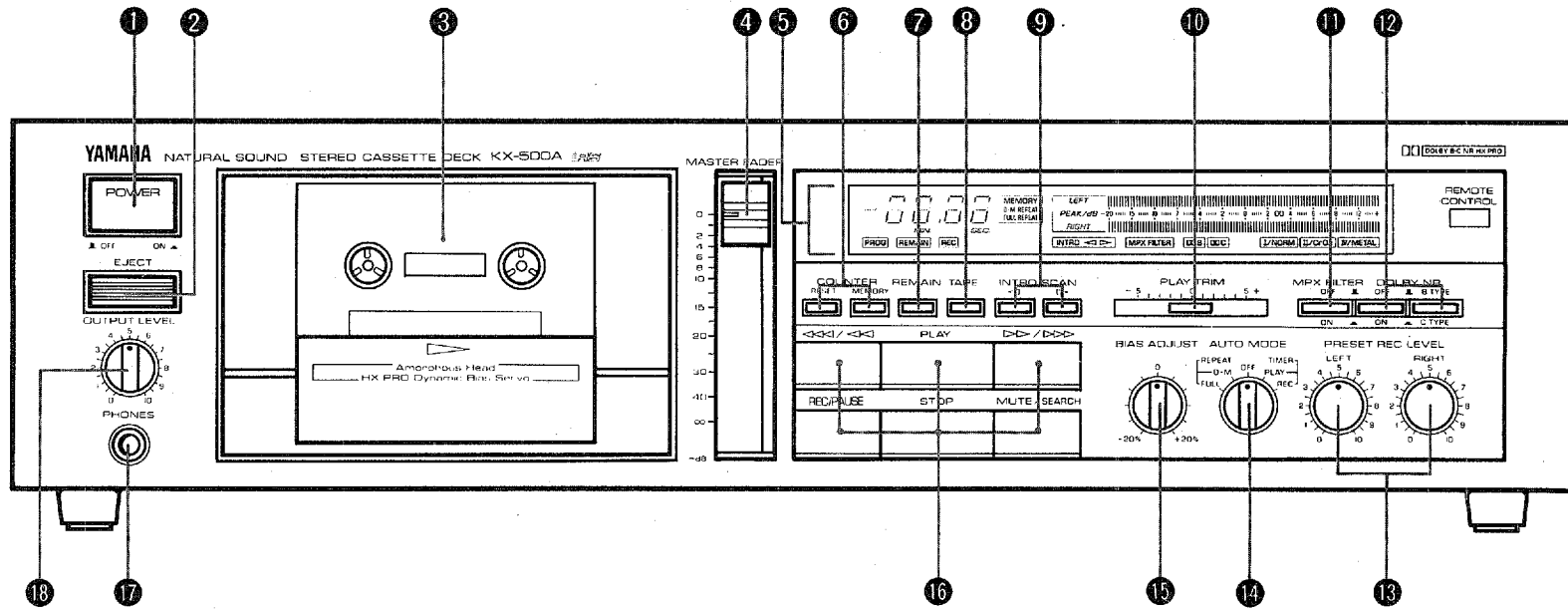

5 Display

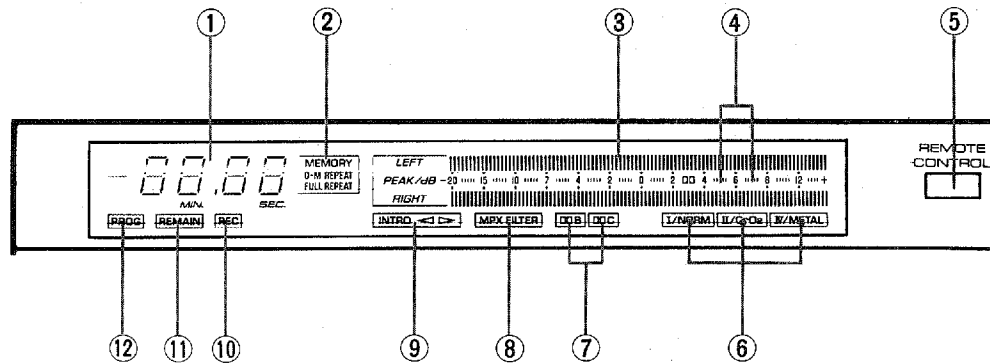

2 REAR PANEL AND CONNECTIONS

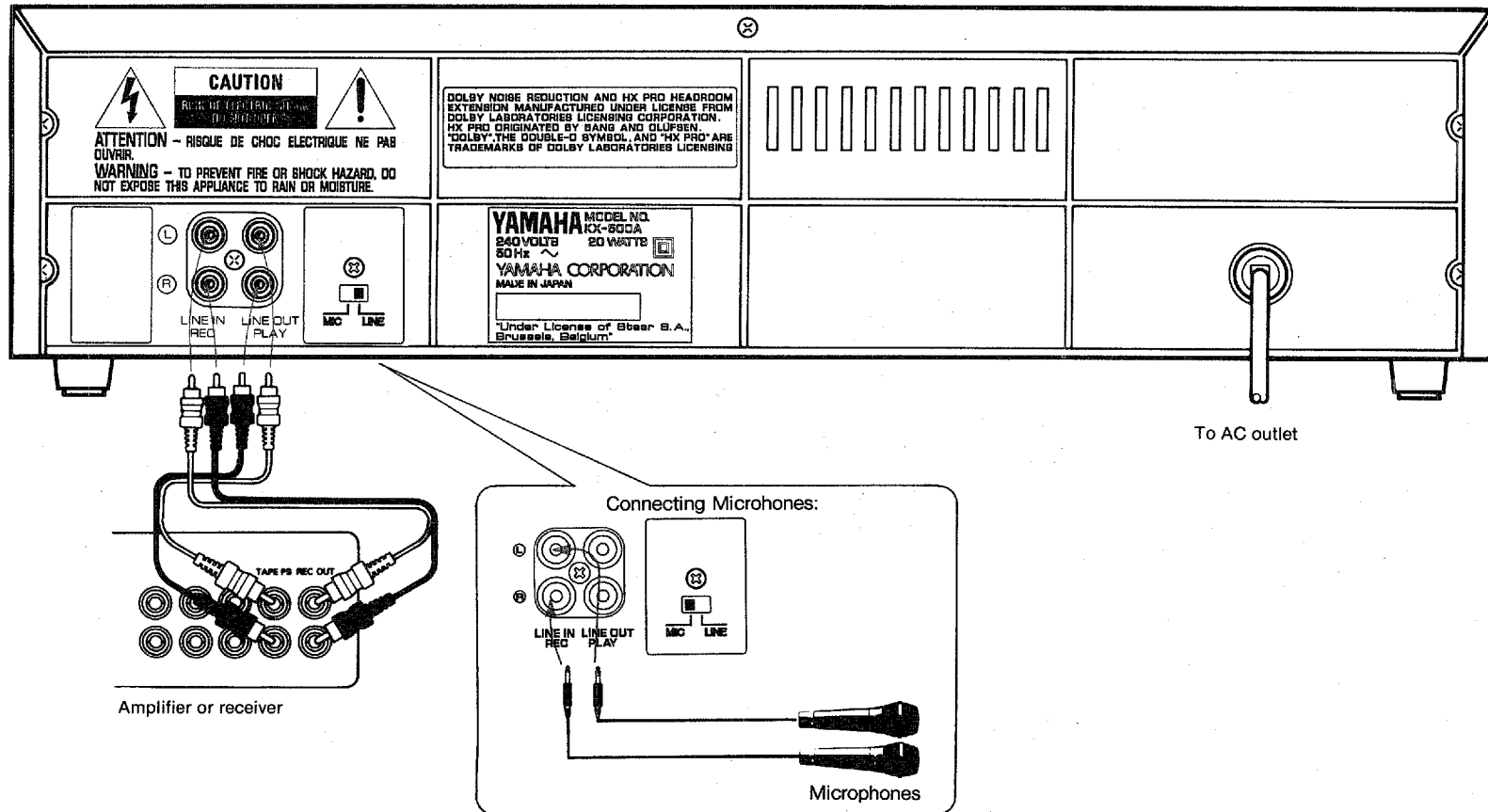

3 DETECTOR SLOTS

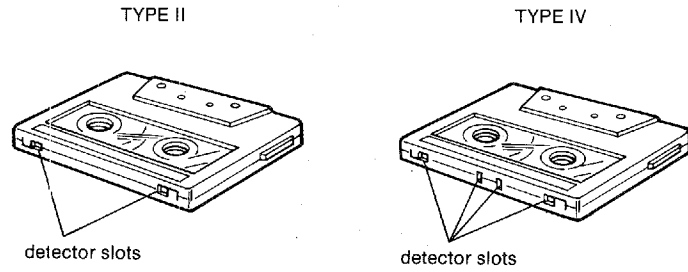

4 RECORDING PROTECTION

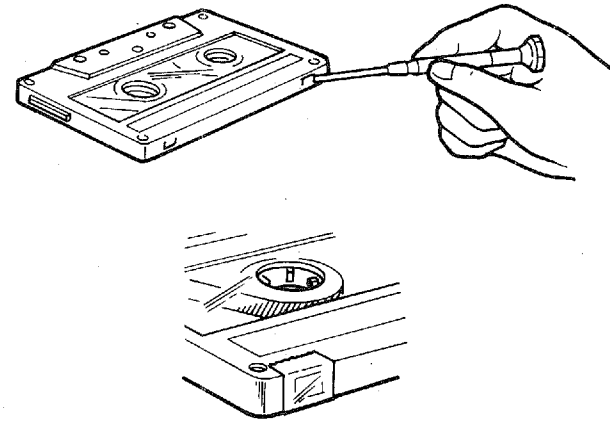

5 TAPE SLACK

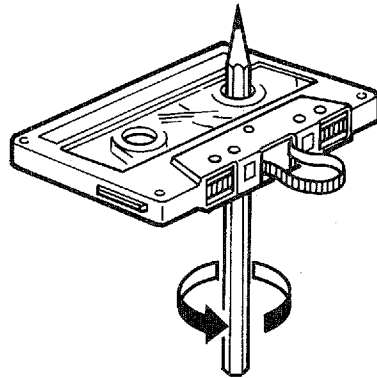

6 TIMER CONNECTION

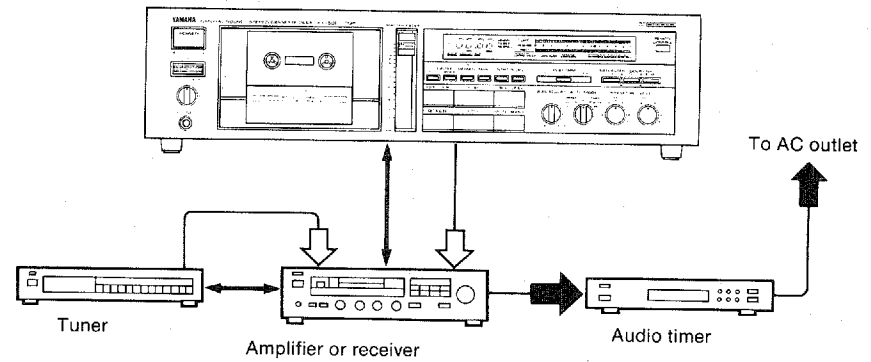

CAUTION: READ THIS BEFORE OPERATING YOUR UNIT.

- 1.** This unit is a sophisticated stereo cassette deck. To ensure proper operation for the best possible performance, please read this manual carefully.
- 2.** Choose the installation of your unit carefully. Avoid placing it in direct sunlight or close to source of heat. Also avoid locations subject to vibration and excessive dust, heat, cold or moisture. Keep it away from such sources of hum as transformers or motors.
- 3.** Do not open the cabinet as this may result in damage to the deck or electrical shock. If a foreign object should get into the deck, contact your local dealer.
- 4.** When removing the power plug from the wall outlet, always pull directly on the plug; never pull the cord itself.
- 5.** Do not use force when operating switches and knobs.
- 6.** When moving the deck, be sure to first pull out the power plug and remove all cords connecting the deck to other equipment.
- 7.** Do not attempt to clean this unit with chemical solvents as this may damage the finish. Use a clean, dry cloth.
- 8.** Never allow metallic items (e.g. screwdrivers, tools, etc.) to come near the record/playback head assembly. Doing so may not only scratch or damage the head's mirror-smooth finish, it may change the magnetic characteristics of the heads, causing a deterioration in reproduction performance quality.
- 9.** Although the record/playback head used in this unit is a high quality Amorphous head with outstanding reproduction characteristics, it can become dirty through the use of old tapes of from dust accumulation over time. This can have a serious effect on reproduction quality. Clean the heads regularly with one of the commonly available head cleaners or with cleaning solutions as explained later in this manual.
- 10.** Be sure to read the "Troubleshooting" section of this manual for advice on common operating errors before concluding that your unit is faulty.
- 11.** Keep this manual in a safe place for future reference.
- 12.** Voltage selector (General model only)
The voltage selector switch on the rear panel of this unit must be set for your local mains voltage before plugging in the AC main supply.

KX-500/U

OWNER'S MANUAL

FRONT PANEL PARTS AND FUNCTIONS

(See Fig. 1.)

① POWER switch

Press this switch to turn the power on and off.

② EJECT button

Press this button to open the cassette compartment.

The button will not function if the deck is in Play, Record or Record/Pause mode.

③ Cassette compartment

To load a cassette tape, press the EJECT button and the cassette compartment will open. Insert a cassette with the exposed tape side facing down and the side to be played facing you. To close the compartment, push in the compartment door until it locks shut.

④ MASTER FADER control

This control is used to simultaneously control the recording levels set by LEFT and RIGHT PRESET REC LEVEL controls. It is useful for creating professional fade-in and fade-out recordings. Normally it should be set to the "0" position.

* The MASTER FADER control functions only during recording.

⑤ Display

① Linear counter/tape length/remaining time/program display

Linear counter: Displays the elapsed time of the tape's running in MINutes and SEconds.

* The linear counter is not an actual clock. Rather, it is a highly accurate counter with minutes and seconds divisions. Its accuracy depends on the kind of tape used.

Tape length: Displays the user selectable tape lengths (C60, C90, C46 and C46L) by pressing the TAPE button.

Remaining time: Displays the remaining playing/recording time of the tape by pressing REMAIN button.

Program: Displays the program number and tune number memorized in that program.

② Repeat function indicators

MEMORY: Lights when a count number has been memorized by pressing the MEMORY button. Pressing the MEMORY button again turns the indicator off and erases the memory.

0-M REPEAT: Lights when the 0-M function is activated, when the AUTO MODE selector is set to 0-M REPEAT.

FULL REPEAT: Lights when the FULL REPEAT function is activated; when the AUTO MODE selector is set to FULL REPEAT.

③ PEAK level meters

Indicate the peaks of the signal levels during recording and playback over a -20 dB to +12 dB range. There are separate meters for each LEFT and RIGHT channel.

④ Optimum recording level indicators

These 2 segments between the numbers of the signal level scale light up depending on the type of tape loaded. They indicate the optimum peak recording level.

⑤ REMOTE CONTROL sensor

This sensor receives signals from the remote control transmitter.

⑥ I/NORM, II/CrO₂, IV/METAL tape type indicators

When a tape is loaded, the built in Auto Tape Selector's sensors will automatically determine what type of tape is loaded, adjust for proper bias, level and equalization for that type of tape, and light the corresponding indicator.

- Automatic tape selection does not function for the early model Metal type tapes which do not have the necessary detector slots.
- The deck is not designed for use with Ferrichrome (III/FeCr) tapes.

⑦ **BBB B and CCC C noise reduction indicators**

The indicators will light to indicate the activation of the corresponding Dolby noise reduction.

⑧ **MPX FILTER indicator**

This indicator lights when the MPX FILTER is activated.

⑨ **INTRO ◀ ▶ indicator**

This indicator lights when the Intro Scan function is activated. It also indicates the direction of the Intro Scan operation.

⑩ **REC indicator**

Lights during the Record and Rec/Pause modes. It will blink on and off during Mute operation.

⑪ **REMAIN indicator**

This indicator blinks on and off for about 5 seconds immediately after pressing the REMAIN button to indicate that the deck is calculating the remaining time. Once the time is calculated, the indicator stays lit and the time is displayed.

⑫ **PROG indicator**

Lights when the RUN key of the remote control transmitter is pressed for programmed playback.

⑥ **COUNTER buttons**

RESET: Press the RESET button to reset the counter reading to "0.00". It can also be used to specify a new "0.00" point and cancel the previous counter readings memorized for 0-M repeat operation.

MEMORY: Press the MEMORY button when the counter is at the desired counter reading. The reading will be memorized and the tape will be played back repeatedly between 0.00 and the memorized counter reading. Press the button again to cancel the reading memorized for 0-M repeat operation.

⑦ **REMAIN button**

When this button is pressed during playback/recording and if the tape length is already memorized via the TAPE key, the unit will compute the remaining available play/record time and display the results in the display. The REMAIN indicator blinks during calculation of the REMAIN time and stays lit once the time is displayed.

* If the tape length has not been memorized by the TAPE function, the unit will calculate the remaining time according to a C-60 tape.

⑧ **TAPE button**

This button is used to memorize the tape length. Each time this key is pressed, the display will change from "C60", "C90", "C46", to "C46L" and the last tape length to be displayed is memorized. It is necessary to memorize the tape length for accurate calculation of remaining tape time and to lock the extra high speed tape winding functions.

⑨ **INTRO SCAN ◀ and ▶ buttons**

Press one of these buttons to play back the approximately first 15 seconds of each selection in the desired direction. Once the desired selection is found, press the PLAY button to defeat the Intro Scan mode and engage the Play mode.

⑩ **PLAY TRIM tone control**

PLAY TRIM is a newly developed feature which functions to increase the compatibility between this unit and tapes recorded on another deck. During playback slide this control to the right to boost high frequencies or slide it to the left to attenuate them. (Refer to "PLAY TRIM" section).

⑪ **MPX FILTER switch**

Press this switch to the ON position when recording broadcasts from FM stations while using a Dolby NR system. Set this switch to OFF when recording sources other than FM broadcasts, and during playback of any tape, even a recording of an FM broadcast.

- * FM stations transmit a 19 kHz pilot signal in addition to the broadcast program. Sometimes this pilot signal may leak into the audio output depending on the tuner and broadcast conditions. This signal can cause improper operation of the Dolby NR systems. Activating the MPX filter will effectively remove the signal.

⑫ **DOLBY NR switches**

OFF/ON switch:

Set this switch to the OFF position if no noise reduction is desired. In the OFF position, signals do not pass through the noise reduction circuits and are output unprocessed.

Set the switch to ON position if Dolby noise reduction is desired.

B TYPE and C TYPE switches:

When playing tapes encoded with Dolby NR or making recordings to be encoded with Dolby NR, set this switch to the desired type of Dolby noise reduction B TYPE or C TYPE, and set the OFF/ON switch to ON. The corresponding indicator in the display will light.

- Dolby noise reduction is an extremely effective method of reducing undesirable background hiss on tapes. This unit incorporates both Dolby B NR and the newer Dolby C NR systems. The newer Dolby C NR is approximately twice as effective as the earlier Dolby B NR.

⑬ **PRESET REC LEVEL LEFT and RIGHT controls**

These controls are used to adjust and set the recording levels for the LEFT and RIGHT channels. Turning a control clockwise increases the recording level, and turning it counterclockwise decreases the recording level. For optimum recording level settings, see "SETTING THE RECORDING LEVEL".

⑭ **AUTO MODE selector**

OFF: For normal playback or recording, set to this position.

FULL REPEAT: In this position (the FULL REPEAT indicator lights), one side of the cassette can be repeatedly played back 8 times from beginning to end.

0-M REPEAT: With the selector set to this position (the 0-M REPEAT indicator lights), the section between "0.00" on the linear counter and the counter number memorized with the MEMORY button (the MEMORY indicator lights) is repeatedly played 8 times (this section must be at least 5 seconds long).

However, if the MEMORY function is not activated (MEMORY indicator is off) but the 0-M REPEAT is selected, any rewinding and fast forwarding of a tape will stop at the display reading of "0.00".

TIMER PLAY: By using a commercially available audio timer, this function permits timer activated playback.

TIMER REC: By using a commercially available audio timer, this function allows you to carry out unattended recording.

- * Be sure to set this selector to OFF when not using the repeat playback feature or the timer feature. If power is turned on with a cassette loaded in the deck and the selector in the TIMER REC position, the Record mode will be engaged and the prerecorded contents of the tape will be erased.

15 BIAS ADJUST control

This control is for fine adjustment of the recording bias. Normally it is not necessary to adjust this control since the deck's Auto Tape Selector automatically adjusts the recording bias for different tape types. Nevertheless, the deck cannot adjust for the wide range of personal preferences or for every brand of tape on the market (bias requirements can vary from brand to brand). Should you feel that your recording needs further bias adjusting (absent or distorted high frequencies), refer to "BIAS ADJUSTMENT" section and adjust this control to your tastes. Turning the control counterclockwise decreases the bias and will result in recordings with boosted high frequencies (treble). Too little bias can result in too much or distorted high frequencies. If less distortion is more important than high frequencies, turn the control clockwise to increase the bias signal.

16 Main operation buttons

◀◀◀/◀◀: Press to rapidly rewind (◀◀) the tape. When the button is kept pressed, the tape is rewound at an extra high speed (◀◀◀) of approximately 1.5 times the normal speed. Furthermore, if the tape length has been input previously into the deck via the TAPE button, and the button is pressed for at least 2 seconds and then released, the extra high speed will be maintained without button pressure.

By pressing this button during recording, the tape will rewind to the beginning of the recording and stop (Rec Return function). If the RESET or the PLAY button was pressed (this does not affect the recording) during recording, the tape will rewind and stop at the point on the tape where the button was pressed.

PLAY: Press this button to begin playback or to engage the Record mode from the Rec/Pause mode. Pressing this button during recording will designate a new beginning point for the REC Return function (See ◀◀◀/◀◀).

▶▶/▶▶▶: Press this button to rapidly advance (▶▶) the tape. When the button is kept pressed, the tape is advanced at an extra high speed (▶▶▶) of approximately 1.5 times the normal speed.

Furthermore, if the tape length has been input previously into the deck via the TAPE button, and the button is pressed for at least 2 seconds and then released, the extra high speed will be maintained without button pressure.

REC/PAUSE: Pressing this button engages the Rec/Pause mode, and the REC indicator will light. While in this mode, the PEAK level meters will function, allowing you to monitor and set the recording signal level of the deck. (Refer to the "SETTING RECORDING LEVEL" section on page 16). To initiate recording from the Rec/Pause mode, press the PLAY button. Pressing the REC/PAUSE button during actual recording engages the Rec/Pause mode once again.

STOP: Pressing this button at any time will stop all tape transport functions.

MUTE/SEARCH:

● During Recording (MUTE):

When the MUTE/SEARCH button is pressed at any time during recording, a 4-second blank interval is automatically recorded onto the tape (Auto Rec Mute mode), then the Rec/Pause mode is engaged immediately thereafter.

In order to record a blank interval longer than 4 seconds, press the MUTE/SEARCH button and hold it down for the desired length of time. After the button is released, the additional 4-second blank interval will also be recorded, then the Rec/Pause mode is engaged immediately thereafter. When the MUTE function is operating, the REC indicator lights on and off.

● During Playback (SEARCH):

By pressing the MUTE/SEARCH and ▶▶/▶▶▶ buttons simultaneously, the tape will advance to the beginning of the next selection and begin play.

CONNECTIONS

By pressing the MUTE/SEARCH and ◀◀◀/◀◀ buttons simultaneously, the tape will rewind to the beginning of the current selection and begin play. Pressing these buttons when using the Direct Music Search function (see DIRECT MUSIC SEARCH in the OPERATIONS section of this manual) will begin the operation.

* SEARCH functions cannot take place at extra high speed.

⑰ PHONES jack

Connect headphones to this jack for monitoring recording or playback.

⑱ OUTPUT LEVEL control

Use this control to adjust the output level at the PHONES jack and LINE OUT/PLAY jacks at the rear. Turn the control to the clockwise to increase, or counterclockwise to decrease, the output level.

■ REAR PANEL CONNECTIONS (See Fig. 2.)

Make sure that power to both the deck and your amplifier/receiver are turned off before making any connection.

The White plug on the paired connecting cables corresponds to the Left channel and the Red plug corresponds to the Right channel. The LINE OUT/PLAY jacks on the deck should be connected to the Tape PB (Playback/Input) jacks on your amplifier/receiver, and the LINE IN/REC jacks on the deck should be connected to the Rec Out (Rec/Output) jacks on your amplifier/receiver. Make sure that the left and right channel connections are properly made, and that the plugs are inserted firmly. Connect the power cord to an AC wall outlet or to an AC outlet on the rear panel of your amplifier/receiver (if provided).

FEATURES

■ DOLBY NOISE REDUCTION

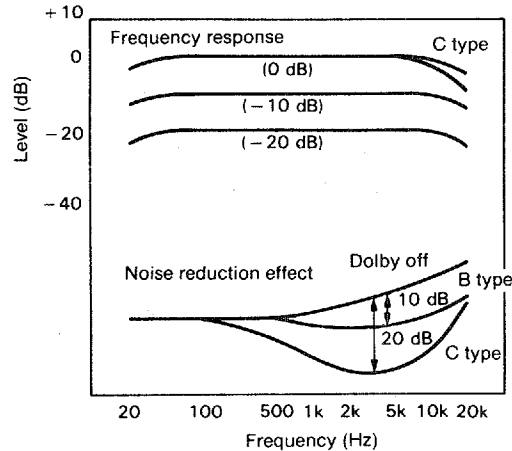

With cassette tapes, the most noticeable form of noise is high frequency hiss. To reduce this hiss noise, the unit is equipped with the newer Dolby C noise reduction system in addition to the older Dolby B NR. Either type of noise reduction may be selected with the DOLBY NR selector. The older Dolby B system is still very handy when playing back that extensive library of Dolby B encoded tapes as well as recording tapes that will be played back on a system which offers only this kind of noise reduction system (some car, portable, and older cassette decks).

Dolby B NR has a noise reduction effect of about 10 dB in the high frequency range. The corresponding effect with Dolby C NR is about 20 dB, but this is over the entire range where the human ear is most sensitive to noise (2 kHz to 8 kHz). Dolby C NR also improves the tape's MOL (Maximum Output Level).

Dolby C NR has two new circuits: a spectral skewing circuit which is responsible for a reduction in the number of encode/decode errors, and an anti-saturation network which improves the saturation level of the tape, resulting in reduced high frequency loss and improved dynamic range. With Dolby C NR, it is possible to achieve the same noise reduction effect at both high and low signal levels and to set the recording level to a point where negative side effects are eliminated. Also, by expanding the operating frequency range to two octaves more than that of Dolby B NR, overall noise balance is obtained and the system also becomes effective against high frequencies from the power supply transformer.

The graph shows the frequency response and the noise reduction effect of recording and playback with Dolby B NR and Dolby C NR. The noise reduction effect of Dolby C NR is larger — approximately 20 dB.

Dolby noise reduction is a 2 part process that acts both on recording and playback; be sure that the DOLBY NR switch is set to the same position during record and play.

- * Tapes encoded with Dolby NR should be decoded with their respective systems. Nevertheless, a Dolby encoded tape can be played back without decoding (and vice versa) with no harm to the recording.
- * Noise in the source material cannot be reduced with the Dolby NR system.

■ HX PRO DYNAMIC BIAS SERVO SYSTEM

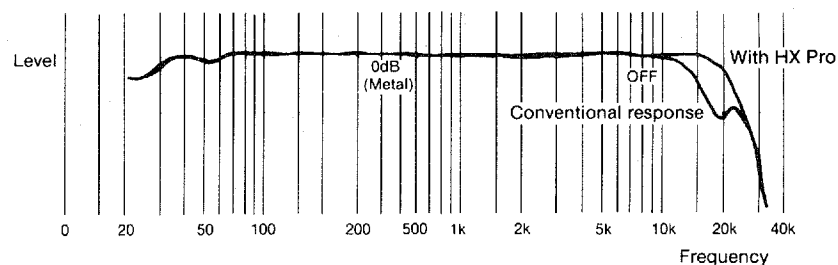

When recording, a bias current according to the tape type used is applied to the recording head as well as the music signal to improve the distortion rate. Furthermore, the extreme high frequency content of a music signal can actually act as bias, adding to the deck's own bias signal to produce over-bias conditions. The result is the deterioration of the high frequency components of the music signal.

To remedy this, the Dolby HX Pro system monitors the total amount of effective bias during recording, and instantaneously compensates for any excess bias by reducing the deck's bias signal level accordingly. The deck operates independently on each channel.

Since HX Pro is not a noise reduction system because it functions only in recording and no decoding is required, a tape recorded with the HX Pro system can be played back on any other cassette deck while retaining the benefits of HX Pro.

Dolby Noise reduction and HX Pro headroom extension are manufactured under license from Dolby Laboratories Licensing Corporation. HX Pro originally developed by Bang & Olufsen.

"DOLBY", the double-D symbol  and "HX PRO" are trademarks of Dolby Laboratories Licensing Corporation.

■ PLAY TRIM

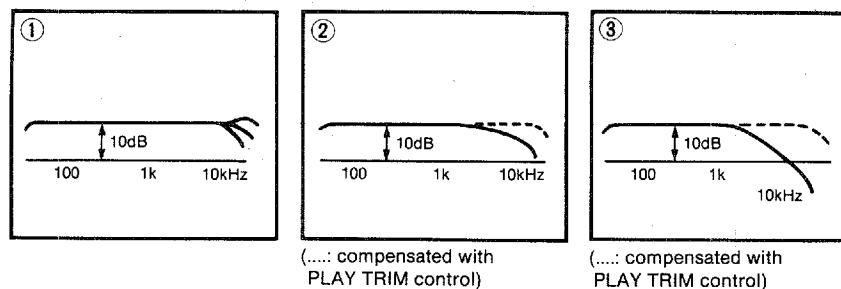

Tapes recorded on one deck can be played back on another. However, slight differences occur between any two decks such as playback frequency response and head azimuth. To solve this problem, this unit incorporates a newly designed PLAT TRIM control.

Fig. ① shows the frequency response curve for recording and playback on this deck. The PLAY TRIM circuit makes it possible to control the playback frequency response by approximately ± 3.5 dB at 10 kHz.

Fig. ③ shows the frequency response curve for playback on this deck of a tape recorded on a deck with Dolby NR ON. When Dolby C is ON, the response compensation can extend up to more than ± 10 dB. The figure shows a drop of 10 dB in the frequency response at 10 kHz.

However, in some cases, the high frequency response is emphasized. By adjusting the PLAY TRIM control, music tapes recorded on other decks can be played back without high frequency degradation.

Fig. ② shows the frequency response curve for playback on this deck of a tape recorded on a deck with Dolby NR OFF. The figure shows a drop in the high frequency response at 10 kHz. But in some cases, the high frequency response is emphasized.

The PLAY TRIM control is similar to the treble tone control of an amplifier, and is characterized by the fact that it can be controlled even when Dolby NR is ON, because it functions between the playback equalizer and the Dolby NR decoder circuits.

During playback, slide the PLAY TRIM control to the position which offers the most agreeable sound quality.

CASSETTE TAPES

BIAS ADJUSTMENT

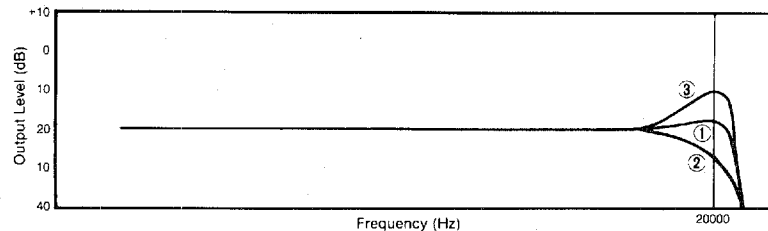

- ① Optimum bias setting
Flat frequency response, normal sound quality
- ② Excessive bias (Over bias)
Too little or no high frequency sound
Turn BIAS ADJUST counterclockwise
- ③ Insufficient bias (Under bias)
Emphasized high frequency sound
Turn BIAS ADJUST clockwise

This control is for fine adjustment of the recording bias. Normally it is not necessary to adjust this control since the deck's Auto Tape Selector automatically adjusts the recording bias for different tape types. Nevertheless, the deck cannot adjust for the wide range of personal preferences or for every brand of tape on the market (bias requirements can vary from brand to brand). Should you feel that your recording needs further bias adjusting (absent or distorted high frequencies), refer to the figure and adjust this control to your tastes. Turning the control counterclockwise decreases the bias and will result in recordings with boosted high frequencies (treble). Too little bias can result in too much or distorted high frequencies. If distortion is more important than high frequencies, turn the control clockwise to increase the bias signal.

CASSETTE TAPES

There are many different types of cassette tapes available, however, they all conform to standard specifications so any brand may be used with the deck.

- * YAMAHA does not recommend the use of 120 minute length cassettes since the extreme thinness of the tape makes them susceptible to mechanical and recording problems.
- Classification of Cassettes Tapes by Formulation
Cassette tapes are available in four basic types depending on their formulation, or type of magnetic material and manufacturing process. These four types are commonly known as Normal (Type I/NORM), Chrome (Type II/CrO₂), Ferrichrome (Type III/FeCr), and Metal (Type IV/METAL), and they each require specific tape deck adjustments for optimum performance.

AUTO TAPE SELECTOR DETECTION SLOTS

(See Fig. 3.)

The deck has a built-in Auto Tape Selector which automatically adjusts for the proper bias, level and equalization according to the tape formulation — all you have to do is load a cassette and the Auto Tape Selector does the rest.

The Auto Tape Selector determines what type of tape is loaded by sensing detector slots in the top of a tape shell. Each tape formulation has its own characteristic hole markings which has been standardized by the tape industry.

- Early model Metal (Type IV/METAL) tape formulation cassette shells do not have the slots for Auto Tape Selector operation. As a result, early model Metal type tapes recorded on another deck will be played back with the deck at the Chrome (Type II/CrO₂) settings. YAMAHA does not recommend recording with this kind of tape on the deck.

- The deck does not have the required setting for Ferrichrome (Type III/FeCr) tape, since this tape formulation is not widely used. Should you use a Ferrichrome tape, it will be recorded and played back at the Normal (Type I/NORM) settings. And this will result in an unnatural high frequency emphasis. This effect may be compensated for somewhat by adjusting the BIAS ADJUST to the plus (+) direction during recording, or by using the PLAY TRIM tone control and/or the tone controls of your amplifier/receiver during playback.

■ PROTECTING YOUR RECORDINGS (See Fig. 4.)

All cassette tapes are provided with erasure protection holes to prevent accidental erasure of recorded contents. There is a small tab covering the hole on each cassette, and it should be broken off after recording a tape. Without this tab covering the hole, it is impossible to record onto that tape. Thus, you can safely protect a recording for as long as you wish without fear of accidental erasure. Should you wish to use a cassette tape protected in this way for recording, simply covering the hole with adhesive tape will permit erasure and re-recording.

- * When using Chrome (Type II/CrO₂) or Metal (Type IV/METAL) tapes, make sure you do not cover the hole intended for the Auto Tape Selector operation.

■ TAKING UP SLACK IN THE TAPE (See Fig. 5.)

As a precaution against tape entanglement and damage, before inserting cassettes into the deck, remove any slack in the tape. This is accomplished by inserting a pencil, pen or similar object into one of the spools and gently winding it until all the slack is removed. You do not have to wind it too tightly.

Be careful not to touch the tape part itself. It is very delicate and touching it may damage the tape and its recorded contents.

■ STORING CASSETTES

After putting a cassette tape back into its case, store in a location away from exposure to direct sunlight, humidity, high temperatures, and magnetic fields (away from television sets, speakers, etc.). High temperatures and humidity will damage the tape itself, while exposure to magnetic fields may cause a loss of recorded material. Avoid touching the tape surface with your fingers, since dirt or finger oil will contaminate the deck's heads.

OPERATION

RECORDING

1. Make sure the AUTO MODE selector is not set to either TIMER REC or TIMER PLAY. Turn the POWER on.
2. Load a cassette tape to be recorded. The Auto Tape Selector determines what type of tape is loaded, internally adjusts bias and equalization, and indicates the optimum recording level. Enter the tape's length via the TAPE button.
3. Select the Dolby noise reduction system with the DOLBY NR switches. Turn the MPX FILTER switch ON if recording an FM broadcast.
4. Adjust the BIAS ADJUST control if desired. See "BIAS ADJUSTMENT".
5. Set the MASTER FADER control to the "0" position.
6. Press the REC/PAUSE button to engage the Rec Standby mode, and play a section of the program to be recorded. To prevent tape over-saturation, it is best to play the loudest passage of the source and to set the recording level based on that passage.
7. Observe the peak readings of the signal meters and turn the REC LEVEL controls to the point such that the meters light up to but not beyond the optimum recording level indicator. Normally, it is best to adjust the separate LEFT and RIGHT PRESET REC LEVEL controls such that the left and right meter readings are even.
If using the fade-in, set the MASTER FADER to the "-∞ dB" position at this time.
8. Reset the source to be recorded back to the beginning. Press the PLAY button to begin recording and immediately begin play of the source.
If using the fade-in, gradually slide the MASTER FADER control up to "0".
9. To temporarily stop the recording, press the REC/PAUSE button. To resume recording, perform step 8.

10. To stop the recording, press the STOP button. To end the recording with fade out, gradually lower the MASTER FADER control to the "-∞ dB" position and press the STOP button. To stop recording conventionally, press the STOP button.
 - When the MUTE/SEARCH button is pressed during recording, a 4-second blank interval is automatically recorded on the tape, then the Rec/Pause mode is engaged (Auto Rec Mute mode).
 - When the ◀◀◀/◀◀ button is pressed during recording, the tape is automatically rewound to the point at which the recording started (Rec Return).
 - When the linear counter is RESET to "0.00" during recording, when the Rec Return function is activated the tape will be automatically rewound to the "0.00" point.
 - Pressing the REMAIN button during recording will display the remaining available recording time.

■ SETTING THE RECORDING LEVEL

Setting the recording level is an important point for proper recording. The PEAK level meters of this cassette tape deck are equipped with optimum recording level indicators. These indicators do away with the guess work previously associated with setting the recording level. These optimum level indicators appear as blue lighted segments between the numbers of the signal level scale. They automatically change position according to the tape type loaded (determined by the Auto Tape Selector). Consequently, setting the optimum recording level is an accurate and simple operation, enabling the full dynamic range of the tape to be exploited.

1. Load a cassette tape to be recorded.
2. Select the noise reduction system with DOLBY NR switches. Dot indicator indicates the optimum recording level.
3. Press the REC/PAUSE button to engage the Rec Standby mode, and play a selection of the program to be recorded.

4. Watch the PEAK level meters and keep the meter reading no higher than dot indicator (optimum level indicator) by adjusting the PRESET REC LEVEL controls.
- Make sure that the MASTER FADER control is set to "0" position.

■ Fade-in and Fade-out recording

Fade-in will cause the recording level to gradually increase to the preset level established by the PRESET REC LEVEL, and Fade-out will cause the recording level to gradually decrease from the preset level. Both functions can be controlled as desired. Using these functions to commence recording during a selection or for the gradual fading out of a selection will give a distinctly professional touch to your recordings.

● Fade-in recording

Set the MASTER FADER control to " $-\infty$ dB". Gradually raise the control to the "0" position.

● Fade-out recording

Set the MASTER FADER control to "0". Gradually lower the control to the " $-\infty$ dB" position, and then stop the recording.

NOTE:

The fade-in and fade-out features will not function during playback. These functions will operate only during recording.

NOTE:

Please check the copyright laws in your country to record from records, compact discs, radio, etc. Recording of copyright material may infringe copyright laws.

PLAYBACK

1. Make sure that the AUTO MODE selector is not set to the TIMER operations, then turn on the POWER switch.
 2. Open the cassette compartment by pressing the EJECT button and load a recorded cassette tape. Enter the tape's length via the TAPE button.
 3. For a tape recorded with a noise reduction system, set the DOLBY ON/OFF switch to ON and the B TYPE/C TYPE switch according to the system used in recording.
 4. Press the PLAY button to start playback.
 5. Set the PLAY TRIM tone control on the deck and the volume and tone controls on the amplifier/receiver to adjust sound quality as desired.
 6. To stop playback, press the STOP button.
- Pressing the REMAIN button during playback will display the remaining playing time of the tape.

■ 0-M REPEAT PLAYBACK

With this function, the desired section can be played back repeatedly up to 8 times.

1. Set AUTO MODE selector to 0-M REPEAT position.
2. Press RESET button at one end of the section you want to repeatedly play. The counter reads "0.00".
3. Press the MEMORY button at the other end of the section. The MEMORY indicator lights up. If the "0.00" point is at the beginning of the section, then the tape immediately begins rewinding.
4. The tape is rewound until the counter has returned to the beginning of the section. The deck then enters the playback mode.

5. The tape plays until it reaches the specified end of the section, rewinds to the beginning, and plays again. In this way, the same selection can be repeatedly played 8 times. After the 8th time, the deck stops. At this time you can repeat the selection again by pressing the PLAY button.
6. To erase the memory, press the MEMORY or RESET buttons once again. The MEMORY indicator goes out.
 - The length between the start and end points of the 0-M repeat section should be more than 5 seconds.
 - The 0-M repeat can be carried out between a minus counter reading and "0.00" (the MEMORY point before the "0.00" point.)

■ FULL REPEAT PLAYBACK

Set the AUTO MODE selector to FULL REPEAT and start playback. The one side of the cassette is repeatedly played back 8 times. When the AUTO MODE selector is set to FULL REPEAT, the FULL REPEAT indicator lights.

■ INTRO SCAN

During playback, press either of the INTRO SCAN buttons. The beginning of each selection is played back for about 15 seconds in the selected direction. Press the PLAY button once the desired selection is found. The deck will enter normal Play mode.

■ DIRECT MUSIC SEARCH

NOTE:

The DIRECT MUSIC SEARCH function can be controlled via the RS-K5 remote control transmitter only.

With direct music search it is possible to program the deck to play a selection located up to 99 selections after or 98 selections before that which you are now listening to or stopped at.

Example: For listening to the selection located 10 selections after the current tune:

1. Press the "1" key and "0" key on the remote control transmitter. The display indicates "--10".
2. Press the SEARCH ►► key on the remote control transmitter. The tape will be fast forwarded to the beginning of the selected selection. As the deck searches for the 10th tune, the display will count down the number of tunes remaining to be passed. Once the tune is reached, the display reverts to normal and playback starts automatically.
 - Be sure to press the SEARCH key within 3 approx. seconds. Otherwise, direct music search is not possible.
 - When the specified selection does not exist on the tape, the tape will be fast wound to the end and the direct music search will be canceled.
 - When a fast rewind, fast forward, PLAY or STOP button is pressed while searching, the direct music search will be canceled.

■ FOR TROUBLE-FREE OPERATION FOR BLANK SEARCH FUNCTION

Scan and search functions operate by searching the tape for a noise-free, blank section. To ensure error-free operation, please follow these precautions:

- Use a tape that is free from noise or previously recorded music in the blank portions between selections.

- Do not use tape that include selections with long silences or low level passages.
- The blank section must be at least 4 seconds long.

■ PROGRAMMED PLAYBACK

NOTE:

The PROGRAMMED PLAYBACK function can be controlled via the RS-K5 remote control transmitter only.

You can select up to 9 selections and rearrange them in any order desired. The deck allows you to select from the first to the 99th selection.

Example: Program 1, 2nd selection: "P1. 2"

Program 2, 10th selection: "P2. 10"

1. Press the PROG key on the remote control transmitter. The program number "P1." appears on the display.
2. Press the "2" key on the remote control transmitter. "P1. 2" appears on the display and the selection number "2" blinks.
 - * Be sure to press the numeric key within approx. 20 seconds. Otherwise, the program display will change to counter display and programming is not possible. In this case, press the PROG key again to call the program number to be memorized.
 - To correct the selection number, press the "0" key and then enter the correct number.
3. Press the PROG key to memorize the selection number. The first programmed selection is memorized. Program number "P2." appears on the display to indicate that the deck is ready to memorize a second selection.
4. Press the "1" key. "P2. 1" appears on the display and the selection number "1" blinks.
5. Press the "0" key. "P2.10" appears on the display and the selection number "10" blinks.
6. Press the PROG key to memorize the second program.

7. When the program is set during playback, fast forward or fast rewind, press the STOP key.
8. Press the RUN key on the remote control transmitter. The tape will be fully rewound and the playback starts in the programmed order. (The program number blinks during music search.)
The display shows the program number and the selection number which is now playing. After termination of programmed playback, "End" display lights on the display. To stop the playback, press the STOP button.
 - Programmed playback does not repeat. To start programmed playback once again, press the RUN key.
 - Programming is possible during Stop, Play, Fast Forward or Fast Rewind mode, but programmed playback can start only during Stop mode.
 - When the specified selection number is searched for but cannot be found, "End" display blinks and the playback stops. When this display appears, check the programmed contents.

To check programmed contents

1. Press the STOP key.
2. Each time the PROG key is pressed, the program number and memorized selection number are displayed in programmed order.

To clear the entire programmed contents

1. Press the STOP key.
2. Press the CLEAR key on the remote control transmitter.
 - When the POWER switch is pressed to OFF, the content of the program is also cleared.

To correct the programmed contents

1. Press the STOP key.
2. Press the PROG key to call the program number to be corrected.
3. Press the numeric key(s) according to new selection number.
4. Press the PROG key to memorize the new selection number.

TIMER RECORDING/PLAYBACK (See Fig. 6)

When using the AUTO MODE selector's TIMER REC or PLAY functions in combination with a commercially available audio timer, it is possible to make recordings and initiate playback at any time automatically.

Timer Recording

1. Make sure that all power cord connections between the timer and amplifier/receiver are properly made. No change in any of the other connections between deck and amplifier/receiver, etc., are necessary.
2. After turning on the power to each component, select the station on your tuner which you want to record and turn down the volume on your amplifier/receiver. This will have no effect on the recording signal level. Remember to set the proper recording level.
3. Set the timer to the desired times. It is advisable to set the timer to begin recording slightly before and end slightly after the actual broadcast recording time, so that you leave some room for later editing.
4. Set the AUTO MODE selector to the TIMER REC position.
5. The timer will send power to the amplifier/receiver, tuner and deck at the preset time, turning all the components on and initiating the recording mode.
- Be sure to set this selector to OFF when not using the repeat or timer features. If power is accidentally turned on with a cassette loaded in the deck and the selector in the TIMER REC position, the Record mode will be engaged and the recorded contents of the tape will be erased.

NOTE:

If the tape cannot be ejected after timer recording, turn the AUTO MODE selector OFF and the deck's POWER switch ON. The tape can then be ejected.

Timer Playback

1. All connections are the same as for timer recording.
2. Turn on the amplifier/receiver and adjust the Volume and Tone controls.
3. Set the input mode selector of your amplifier/receiver to the Tape mode.
4. Set the timer to the time you wish to start and stop playback.
5. Set the AUTO MODE selector to the TIMER PLAY position.
6. At the preset time, the timer will turn power on to the amplifier/receiver and tape deck and begin playback. It will shut power OFF, at the preset time as well ending playback.

MAINTENANCE

■ CLEANING OF TAPE PATH

The continued high quality performance of your deck is dependent upon regular periodic cleaning of the heads, capstan, pinch roller, and all surfaces over which the tape travels. Normal use will see an accumulation of dirt and dust on the heads, capstans, and pinch rollers. This can lead to poor sound quality, drop outs (intervals with no sound), unsteady tape speed, loss of high frequency response, etc. We recommend commercially available cassette and fluid type cleaners.

■ DEMAGNETIZATION

After 20-30 hours of use, enough residual magnetism will have built up on the heads to cause poor high frequency reproduction. At this time you should use a commercially available head demagnetizer.

- When demagnetizing the heads, be sure to follow the instructions of the head demagnetizer carefully.

■ CLEANING THE CABINET

Clean the cabinet with a soft cloth lightly moistened with a mild detergent. Never use solvents such as benzine, acetone, alcohol, etc. for they may damage the deck's finish.

TROUBLESHOOTING

If your cassette deck fails to operate normally, check the following table. It lists common operating errors and simple measures which you can take to correct the problem. If it cannot be corrected, or the symptom is not listed, disconnect the deck's power cord and contact your local YAMAHA dealer or service center for help.

Fault	Cause	Cure
Tape doesn't move in recording or playback	<ul style="list-style-type: none"> ● Power plug not properly plugged in. ● End of tape. ● Cassette shell is warped or damaged. 	<ul style="list-style-type: none"> ● Reinsert plug properly. ● Rewind tape or flip it over. ● Do not play damaged tapes.
REC/PAUSE button fails to function.	<ul style="list-style-type: none"> ● No cassette tape loaded. ● Recording protection tab is broken off. 	<ul style="list-style-type: none"> ● Load a cassette tape. ● Change to different tape, or cover the hole remaining after removal of tab with cellophane tape.
Sounds become faint and sometimes inaudible.	<ul style="list-style-type: none"> ● Head is dirty. ● Head is magnetized. ● Tape is damaged or of poor quality. 	<ul style="list-style-type: none"> ● Clean head using cleaning tape. ● Demagnetize head using head demagnetizer. ● Change to a different tape.
Recorded sound is distorted.	<ul style="list-style-type: none"> ● Tape is bad (stretched or deformed, etc.). ● Cassette shell is warped. 	<ul style="list-style-type: none"> ● Replace with a fresh tape. ● A warped cassette shell cannot be fixed. Replace with another tape and test.
Recorded sounds are distorted.	<ul style="list-style-type: none"> ● Recording level is too high. 	<ul style="list-style-type: none"> ● Check input level with signal level meter and use lower rec level when recording.
Tape is playing back, but no sound is heard.	<ul style="list-style-type: none"> ● Faulty connection between deck and stereo amplifier/receiver. ● The OUTPUT LEVEL control is set to a minimum. 	<ul style="list-style-type: none"> ● Check and secure connections. ● Turn the OUTPUT LEVEL control up.
Excessive noise.	<ul style="list-style-type: none"> ● Head is dirty. ● Head is magnetized. ● Worn out or poor quality tape. ● Connection(s) improperly made. ● Affected by external electrical noise. 	<ul style="list-style-type: none"> ● Clean head. ● Demagnetize head with head demagnetizer. ● Change to better tape. ● Check input and output connections and reinsert properly. ● Move away from electrical appliances (TV, fluorescent light, electric blanket, etc.)
Excessive wow (wavering of the sound).	<ul style="list-style-type: none"> ● Dirty capstan, pinch roller, etc., or poor tape. ● Tape is wound unevenly. 	<ul style="list-style-type: none"> ● Clean capstan, pinch roller, or change to better tape. ● Rewind tape.
Tape stops in the middle of recording or playback.	<ul style="list-style-type: none"> ● Slack tape, or tape spillage wound around capstan. 	<ul style="list-style-type: none"> ● Insert pencil in hole in cassette shell and turn to take up slack.

Fault	Cause	Cure
Fails to record.	<ul style="list-style-type: none"> ● PRESET REC LEVEL controls too low. ● Protective tabs broken off. 	<ul style="list-style-type: none"> ● Adjust PRESET REC LEVEL controls. ● Change tape or cover protective hole with cellophane tape.
Mute Search does not operate.	<ul style="list-style-type: none"> ● Recorded section is too short. ● Recorded section has low-level portions. ● Conversation, etc. has been recorded. 	<ul style="list-style-type: none"> ● Blank sections must be at least 4 seconds long.
High frequencies in the playback sound are emphasized and unpleasant to listen to, and noise level (hiss) is also high.	<ul style="list-style-type: none"> ● Dolby-recorded tape is played back in OFF position. 	<ul style="list-style-type: none"> ● Playback in appropriate Dolby position.
Playback sound is muffled and high frequencies are inaudible.	<ul style="list-style-type: none"> ● Normally-recorded tape is played back in DOLBY. ● Heads are dirty. ● Heads are magnetized. 	<ul style="list-style-type: none"> ● Playback in OFF position. ● Clean heads and carry out demagnetization with head demagnetizer.
When playing back tapes recorded on other decks, meter deflections are greater (smaller) than when recording.	<ul style="list-style-type: none"> ● Basic levels are different for different cassette decks. 	<ul style="list-style-type: none"> ● This is not a fault.
Recordings cannot be made.	<ul style="list-style-type: none"> ● PRESET REC LEVEL controls are set too low. ● MASTER FADER control is set too low. 	<ul style="list-style-type: none"> ● Adjust level with the level control. ● Set to "0" position.
Recordings cannot be made with TIMER REC (deck only plays back).	<ul style="list-style-type: none"> ● Protective accidental erasure tabs on cassette have been broken off. 	<ul style="list-style-type: none"> ● Replace cassette tape, or cover tab holes with tape, etc.

SPECIFICATIONS

Track Configuration	4 track, 2 channel stereo
Motor	DC servo motor (capstan) Flat torque DC motor (reel) DC motor (assist)
Heads	Combination, Amorphous with 12-laminated core Rec and Playback heads Double-gap Ferrite erase head
Rapid Transport	
(F.Fwd/Rew)	70 sec. (C-60)
Wow and Flutter	
WRMS	less than 0.05%
W.Peak	less than $\pm 0.08\%$
Signal-to-Noise Ratio	
(Dolby NR off)	better than 60 dB
(Dolby B NR on)	better than 68 dB
(Dolby C NR on)	better than 76 dB
Frequency Response	
Normal tape (-20 dB)	20 — 17,000 Hz ± 3 dB
CrO₂ tape (-20 dB)	20 — 19,000 Hz ± 3 dB
Metal tape (-20 dB)	20 — 20,000 Hz ± 3 dB
Harmonic Distortion	
Normal tape	less than 1%
Chrome tape	less than 1%
Metal tape	less than 1%
Input Sensitivity/Impedance	
Line	50 mV/50 k-ohms
Output Level	
Line	360 mV/1 k-ohm
Phones	1.2 mW/8 ohms
Channel Separation (3150 Hz)	40 dB
Cross Talk (125 Hz)	55 dB

GENERAL

Power Supplies

U.S.A. and Canada models 120 V, 60 Hz

British and Australian models 240 V, 50 Hz

Other Areas 110/120/220/240V, 50/60 Hz

Power Consumption 20W

Dimensions (W x H x D) 435 x 117 x 273 mm
(17-1/8" x 4-5/8" x 10-3/4")

Weight 4.5 kg (9 lbs. 15 oz.)

* Specifications subject to change without notice.

* Dolby noise reduction manufactured under license from Dolby Laboratories Licensing Corporation. "DOLBY" and the double D symbol  are trademarks of Dolby Laboratories Licensing Corporation.

YAMAHA
HAMAMATSU, JAPAN

VG87830-0

YAMAHA CORPORATION
BWgg, BB ℓ CR  Printed in Japan.